

Appendix 1

Case 1

CONTENTS

	PAGE
Claim of the Application	2
Description of the Application	4
Drawings of the Application	23
Published Prior Art 1	29
Published Prior Art 2	44

Case 1

[Claim of the Application]

Appendix 1

[Claim]

An optical information reproducing device that reproduces data by irradiating an optical disc, which is an information recording medium, with laser light, the optical information reproducing device comprising:

rotating device which rotates the optical disc, and
detecting device which detects a data error,

wherein, data is reproduced by rotating the optical disc by means of the said rotating device at the maximum rotational speed in the beginning; data is reproduced by reducing the rotational speed by means of the said rotating device each time when the said detecting device detects a data error in reproducing data; data is reproduced by rotating the optical disc at the unchanged rotational speed when the said detecting device doesn't detect a data error.

Appendix 1

Case 1

[Description of the Application]

Appendix 1

[Detailed Description of the Invention]

[0001]

[Technical Field of the Invention] The present invention relates to an optical information recording/reproducing device that records/reproduces data by irradiating an optical disc or a magneto-optical disc, which is an information recording medium, with laser light. More particularly, the present invention relates to an optical information recording/reproducing device which can record/reproduce data at a rotational speed that is as high as possible within a range of performance of a disc by reducing rotational speed of the disc in steps, when an off-track, a defocus, or a data error occurs as a result of driving the disc at a rotational speed that is higher than a rotational speed determined in accordance with the performance of the disc.

[0002]

[Description of the Related Art] In recent years, progress in computerization has led to advancement in the development of optical discs, which are information recording media. A variety of optical discs that have difference characteristics depending upon differences in, for example, substrates or thin films have been proposed.

[0003]

[Description of the Related Art] In particular, to

Appendix 1

record/reproduce a large amount of information, it is necessary to increase speed, and, to increase the speed, it is necessary to increase rotational speed of an optical disc medium. To increase the rotational speed, first, it is necessary to improve mechanical characteristics of a substrate.

[0004] The mechanical characteristics include, for example, decentering, runout, and tilting of the medium. The values thereof depend upon the material of the substrate and molding conditions. At present, the substrate of the optical disc medium may be, for example, a polycarbonate (PC) substrate, a polymethyl acrylate (PMMA) substrate, an amorphous polyolefin (APO) substrate, or a glass substrate.

[0005] Among these substrates, the most frequently used substrate is the PC substrate from the viewpoint of its suitability for mass production. However, in general, the PC substrate does not have good mechanical characteristic values compared to those of the glass substrate.

[0006] In addition, the PC substrate has a drawback in that its mechanical characteristics vary depending upon its molding conditions. To avoid adverse effects resulting from the variation in the mechanical characteristics, such as decentering, runout, and tilting of the medium, of the PC substrate that is excellent in terms of mass production, it is necessary to restrict the rotational speed of the disc.

Appendix 1

This results in the problem that high-speed rotation cannot be achieved.

[0007] In addition, since recording characteristics of the medium depend upon the linear speed of the disc, if the speed of the disc is increased, recording power that is required is also increased. In general, the relationship between the recording power and the linear speed is linear. Depending upon the type of thin film, the amount of tilting differs.

[0008] A maximum output power of a driving device is restricted by the performance of a laser diode, which is an output source of the output power. Therefore, even if the mechanical characteristics are satisfied, when a film material of a type that does not allow the performance of the driving device to output a required high recording power is used, a recording operation performed by high-speed rotation cannot be achieved.

[0009] Accordingly, to increase the speed of the optical disc, it is necessary to consider, for example, the mechanical characteristics of the disc and restrictions of recording sensitivity of the film material that is used. In addition, the mechanical characteristics of an outer periphery of the medium are poorer than those of an inner periphery of the medium. Therefore, although, when recording is performed on the inner periphery, the

Appendix 1

rotational speed of the inner periphery can be set higher than that of the outer periphery, the recording cannot be performed on the outer periphery if the rotational speed remains unchanged.

[0010] From the viewpoint of data transfer rate, it is desirable for the rotational speed to be high for the driving device. Accordingly, at present, there are various conditions that are required of optical disc media for increasing speed. Moreover, some of them are difficult to satisfy at the same time. Therefore, it is very difficult to achieve an optical information recording/reproducing device which writes/reads data at optimal rotational speeds of optical discs in terms of various materials and molding conditions.

[0011] For example, a speed reducer of a DC servo motor has been known from the past as a device that reduces the speed of a motor in a short time (refer to Japanese Examined Utility Model Registration Application Publication No. 57-57519). Although the related speed reducer can reduce the speed of a low-speed brushless motor in a very short time, the technical concept of reading/writing data as a result of reducing rotational speed does not exist for only the case in which an error occurs at a disc medium.

[0012]

[Problems to be Solved by the Invention] There are various

Appendix 1

such problems occurring in related optical information recording/reproducing devices, that is, there are various conditions that are required of optical disc media for increasing speed. As a result, the optimal conditions for writing/reading data are not necessarily satisfied at the same time in the respective optical discs. Therefore, it is an object of the present invention to provide an optical information recording/reproducing device which solves the problem that it is difficult to efficiently drive each optical disc under optimal conditions, so that the device can record/reproduce data at a rotational speed that is as high as possible within a performance range of each disc.

[0013]

[Means for Solving the Problems] According to the present invention, first, an optical information recording/reproducing device that records/reproduces data by irradiating an optical disc comprises detecting device for detecting an off-track caused by a rotational speed of the optical disc being high, wherein, when the off-track caused by the rotational speed being high is detected, the rotational speed of the optical disc is successively reduced to a rotational speed that does not allow the off-track to occur.

[0014] Second, an optical information recording/reproducing device that records/reproduces data by irradiating an

Appendix 1

optical disc, which is an information recording medium, with laser light comprises detecting device for detecting a defocus caused by a rotational speed of the optical disc being high, wherein, when the defocus caused by the rotational speed being high is detected, the rotational speed of the optical disc is successively reduced to a rotational speed that does not allow the defocus to occur.

[0015] Third, an optical information recording/reproducing device that records/reproduces data by irradiating an optical disc, which is an information recording medium, with laser light comprises detecting device for detecting a data error caused by a rotational speed of the optical disc being high, wherein, when the data error caused by the rotational speed being high is detected, the rotational speed of the optical disc is successively reduced to a rotational speed that does not allow the data error to occur.

[0016]

[Operation] In the present invention, when, for example, an off-track, a defocus, or a data error occurs as a result of driving each optical disc medium at a rotational speed that is higher than a rotational speed that is determined in accordance with the performance of each optical disc medium, the rotational speed of each disc is reduced in steps by a previously set rotational speed to make it possible to record/reproduce data at a high speed that is in accordance

Appendix 1

with the performance of each disc medium (inventions of Claims 1 to 3). More specifically, an initial rotational speed is set to, for example, 3,600 rpm, which is the maximum rotational speed for the performance of present optical disc media.

[0017] Therefore, when an optical disc is set (loaded), the optical disc is rotated at the initially set high rotational speed of 3,600 rpm. Then, data is read/written at this rotational speed. If, for example, an off-track is detected, the rotational speed is successively reduced by, for example, 600 rpm at a time. Each time the rotational speed is reduced, whether or not, for example, an off-track occurs is checked to read/write data at a rotational speed that does not allow, for example, the off-track to occur.

[0018] Examples of mechanical characteristic values based on ISO Standard will be described. Fig. 2 is a table of examples of mechanical characteristic values of a disc based on the ISO Standard. Fig. 2 gives the mechanical characteristic values of a 130-mm disc medium to which data can be rewritten (rewritable: DIS9171). In the ISO Standard, mechanical characteristic values of disc media are prescribed as in Fig. 2.

[0019] In the ISO Standard, as a test condition, mechanical characteristic values for 1,800 rpm are also prescribed. Decentering acceleration (second row in Fig. 2) and runout

Appendix 1

acceleration (fourth row in Fig. 2) are quadrupled when linear speed is doubled. Therefore, the performance of an actuator needs to provide for this. This relationship is shown in the following Fig. 3.

[0020] Fig. 3 shows examples of decentering acceleration values and runout acceleration values that are required of an actuator when rotational speed is increased. Fig. 3 shows a case in which the rotational speed is increased by 600 rpm at a time from the test-condition rotational speed of 1,800 rpm.

[0021] The reason is that, for example, the characteristics of present actuators and mechanical characteristic values of media are considered. As mentioned above, the maximum rotational speed is on the order of 3,600 rpm, so that, if the rotational speed is set in such four steps, it is possible to adequately provide for quite a large number of types of media.

[0022] Therefore, when, in the future, various media are developed, so that the number of mechanical characteristic values of the media is increased, rotational speed thereof can be increased in a larger number of steps, such as 400 rpm or 300 rpm at a time. In addition, when the performance of actuators is enhanced, the maximum rotational speed is set even higher. Here, a description will be given while focusing on a case in which rotational speed is reduced in

Appendix 1

steps on the basis of the performance of present actuators and mechanical characteristics of media.

[0023]

[First Embodiment] Next, an optical information recording/reproducing device according to an embodiment of the present invention will be described in detail with reference to the drawings. This embodiment is primarily related to the invention of Claim 1, but its hardware structure is also related to the inventions of Claims 2 and 3.

[0024] Fig. 1 is a functional block diagram of a structure of main portions of the optical information recording/reproducing device according to the embodiment of the present invention. In the figure, reference numeral 1 denotes an optical disc drive, reference numeral 11 denotes a rotational driving motor thereof, reference numeral 12 denotes a rotation controlling system, reference numeral 13 denotes an optical pickup unit, reference numeral 14 denotes a coarse-movement motor, reference numeral 15 denotes a coarse-movement-motor controlling system, reference numeral 16 denotes a signal processing system, reference numeral 17 denotes a pickup controlling system, reference numeral 18 denotes a drive controller, reference numeral 2 denotes an optical disc medium, reference numeral 3 denotes a drive interface, and reference character L denotes laser light.

Appendix 1

[0025] Features and operations that are common to those of the related art will be described. As shown in Fig. 1, the optical disc medium 2, which is an information recording medium, is set onto the rotational driving motor 11 of the optical disc drive 1 and is rotated by the rotation controlling system 12. Its rotational speed is issued in the form of a rotational-speed command from the drive controller 18.

[0026] The laser light L is emitted from the optical pickup unit 13, and a surface of the optical disc medium 2 is irradiated with the emitted laser light L to write, delete, and read out data. In this case, tracking control and focus control are performed by carrying out servo control operations by the pickup controlling system 17 to which a signal from the signal processing system 16 is applied.

[0027] The read out data is processed by the signal processing system 16, and the processed data is sent to the drive controller 18. The write data provided from the drive controller 18 is provided to the pickup controlling system 17 through the signal processing system 16, and is recorded onto the optical disc medium 2.

[0028] The drive controller 18 is connected to, for example, a host computer (not shown) through the drive interface 3. The above-described structural features and operations are basically the same as those of a related device. The

Appendix 1

optical information recording/reproducing device according to the present invention differs from the related device in that it performs a controlling operation in accordance with the flowcharts of from Figs. 4 to 6 that are described later.

[0029] As has already been mentioned a number of times, in the present invention, when the optical disc medium 2 is set on the optical disc drive 1, the optical disc medium 2 is rotated at an initially set high rotational speed of 3,600 rpm. Data is read/written at this rotational speed.

[0030] If an off-track occurs, the rotational speed is reduced by a predetermined amount of, for example, 600 rpm. If the rotational speed of the optical disc medium 2 is reduced in this way, servo characteristics that are required of an actuator can be provided for, so that the off-track occurs less frequently accordingly.

[0031] If an off-track occurs even if the rotational speed is reduced once, the rotational speed is reduced one more time by the predetermined amount of 600 rpm. When the rotational speed of the optical disc medium 2 is reduced twice in this way and data is read/written at a rotational speed that does not allow the off-track to occur, it possible to rotate the optical disc medium 2 that matches the performance of the optical disc medium 2.

[0032] Fig. 4 is a flowchart of the flow of main operations that are executed when an off-track is detected, in the

Appendix 1

optical information recording/reproducing device according to the present invention. In the figure, "#1" to "#5" denote steps.

[0033] In Step #1, the optical disc medium 2 is loaded onto the optical disc drive 1 shown in Fig. 1. In the next Step #2, the rotational driving motor (spindle motor) 11 is rotated at a previously set rotational speed of, for example, 3,600 rpm.

[0034] In Step #3, data is written/read at the set rotational speed. Then, the process proceeds to Step #4 to monitor whether or not an off-track has occurred.

[0035] If the off-track has not occurred, the process returns to Step #3 to similarly write/read data. In contrast, when the off-track has been detected in Step #4, the process proceeds to the next Step #5 to reduce the rotational speed of the motor by, for example, 600 rpm, and, then, the process returns to the previous Step #3.

[0036] Thereafter, similarly, data is written/read at this reduced rotational speed to detect a rotational speed that does not allow the off-track to occur, so as to write/read data at this rotational speed. The operations of the Steps #1 to #5 make it possible to write/read data at a rotational speed that matches the performance of the optical disc medium.

[0037] That is, in the optical disc drive 1, when a spot of

Appendix 1

the laser light L emitted from the optical pickup unit 13 is off a track, the rotation controlling system 13 reduces the rotational speed of the optical disc medium 2 to perform a controlling operation so as to achieve a track-in state. By this controlling operation, a maximum rotational speed that does not allow the off-track to occur is selected to write/read data.

[0038]

[Second Embodiment] Next, a second embodiment will be described. This embodiment corresponds to the invention of Claim 2, but its hardware structure is the same as that shown in Fig. 1 described in the invention of Claim 1. The second embodiment is basically the same as the previous embodiment. It differs from the previous embodiment in that whether or not a defocus occurs is checked.

[0039] Fig. 5 is a flowchart of the flow of main operations that are executed when a defocus is detected, in the optical information recording/reproducing device according to the present invention. In the figure, "#11" to "#15" denote steps.

[0040] In Step #11, the optical disc medium 2 is loaded onto the optical disc drive 1 shown in Fig. 1. In the next Step #12, the rotational driving motor (spindle motor) 11 is rotated at a previously set rotational speed of, for example, 3,600 rpm.

Appendix 1

[0041] In Step #13, data is written/read at the set rotational speed. Then, the process proceeds to Step #14 to monitor whether or not a defocus has occurred.

[0042] If the defocus has not occurred, the process returns to Step #13 to similarly write/read data. In contrast, when the defocus has been detected in Step #14, the process proceeds to the next Step #15 to reduce the rotational speed of the motor by, for example, 600 rpm, and, then, the process returns to the previous Step #13.

[0043] Thereafter, similarly, data is written/read at this reduced rotational speed to detect a rotational speed that does not allow the defocus to occur, so as to write/read data at this rotational speed. The operations of the Steps #11 to #15 make it possible to write/read data at a rotational speed that matches the performance of the optical disc medium.

[0044] In the second embodiment, in the optical disc drive 1, when a spot of the laser light L emitted from the optical pickup unit 13 is defocused, the rotation controlling system 13 reduces the rotational speed of the optical disc medium 2 to perform a controlling operation so as to achieve a focus state. By this controlling operation, a maximum rotational speed that does not allow the defocus to occur is selected to write/read data.

[0045]

Appendix 1

[Third Embodiment] Next, a third embodiment will be described. This embodiment corresponds to the invention of Claim 3, but its hardware structure is the same as that shown in Fig. 1 described in the invention of Claim 1. The third embodiment is basically the same as the previous first and second embodiments. It differs from the previous embodiments in that whether or not data error occurs is checked.

[0046] Fig. 6 is a flowchart of the flow of main operations that are executed when a data error is detected, in the optical information recording/reproducing device according to the present invention. In the figure, "#21" to "#25" denote steps.

[0047] In Step #21, the optical disc medium 2 is loaded onto the optical disc drive 1 shown in Fig. 1. In the next Step #22, the rotational driving motor (spindle motor) 11 is rotated at a previously set rotational speed of, for example, 3,600 rpm.

[0048] In Step #23, data is written/read at the set rotational speed. Then, the process proceeds to Step #24 to monitor whether or not a data error has occurred.

[0049] If the data error has not occurred, the process returns to Step #23 to similarly write/read data. In contrast, when the data error has been detected in Step #24, the process proceeds to the next Step #25 to reduce the

Appendix 1

rotational speed of the motor by, for example, 600 rpm, and, then, the process returns to the previous Step #23.

[0050] Thereafter, similarly, data is written/read at this reduced rotational speed to detect a rotational speed that does not allow the data error to occur, so as to write/read data at this rotational speed. The operations of the Steps #21 to #25 make it possible to write/read data at a rotational speed that matches the performance of the optical disc medium.

[0051] In the third embodiment, when, in the signal processing system 16 of the optical disc drive 1, a data error occurs, the rotational speed of the optical disc medium 2 is reduced by the rotation controlling system 13 to write/read data again. This makes it possible to write/read data at a rotational speed that does not allow the data error to occur.

[0052]

[Advantages] According to the invention of Claim 1, only when an off-track occurs as a result of rotating a disc, which is an information recording medium, at a rotational speed that is as high as possible is a controlling operation performed so as to reduce the rotational speed of the disc for writing/reading data. Therefore, it is possible to efficiently write/read data at a rotational speed that matches the performance of disc media.

Appendix 1

[0053] According to the invention of Claim 2, only when an defocus occurs as a result of rotating a disc, which is an information recording medium, at a rotational speed that is as high as possible is a controlling operation performed so as to reduce the rotational speed of the disc for writing/reading data. Therefore, similarly, it is possible to efficiently write/read data at a rotational speed that matches the performance of disc media.

[0054] According to the invention of Claim 3, only when a data error occurs as a result of rotating a disc, which is an information recording medium, at a rotational speed that is as high as possible is a controlling operation performed so as to reduce the rotational speed of the disc for writing/reading data. Therefore, similarly, it is possible to efficiently write/read data at a rotational speed that matches the performance of disc media.

[Brief Description of the Drawings]

[Fig. 1] Fig. 1 is a functional block diagram of a structure of main portions of an optical information recording/reproducing device according to an embodiment of the present invention.

[Fig. 2] Fig. 2 is a table of examples of mechanical characteristic values of a disc based on ISO Standard.

[Fig. 3] Fig. 3 shows examples of decentering acceleration values and runout acceleration values that are required of

Appendix 1

an actuator when rotational speed is increased.

[Fig. 4] Fig. 4 is a flowchart of the flow of main operations that are executed when an off-track is detected, in the optical information recording/reproducing device according to the present invention.

[Fig. 5] Fig. 5 is a flowchart of the flow of main operations that are executed when a defocus is detected, in the optical information recording/reproducing device according to the present invention.

[Fig. 6] Fig. 6 is a flowchart of the flow of main operations that are executed when a data error is detected, in the optical information recording/reproducing device according to the present invention.

[Reference Numerals]

- 1: optical disc drive
- 11: rotational driving motor thereof
- 12: rotation controlling system
- 13: optical pickup unit
- *14: coarse-movement motor
- 15: coarse-movement-motor controlling system
- 16: signal processing system
- 17: pickup controlling system
- 18: drive controller
- 2: optical disc medium
- *3: drive interface

Case 1

[Drawings of the Application]

Appendix 1

FIG. 1

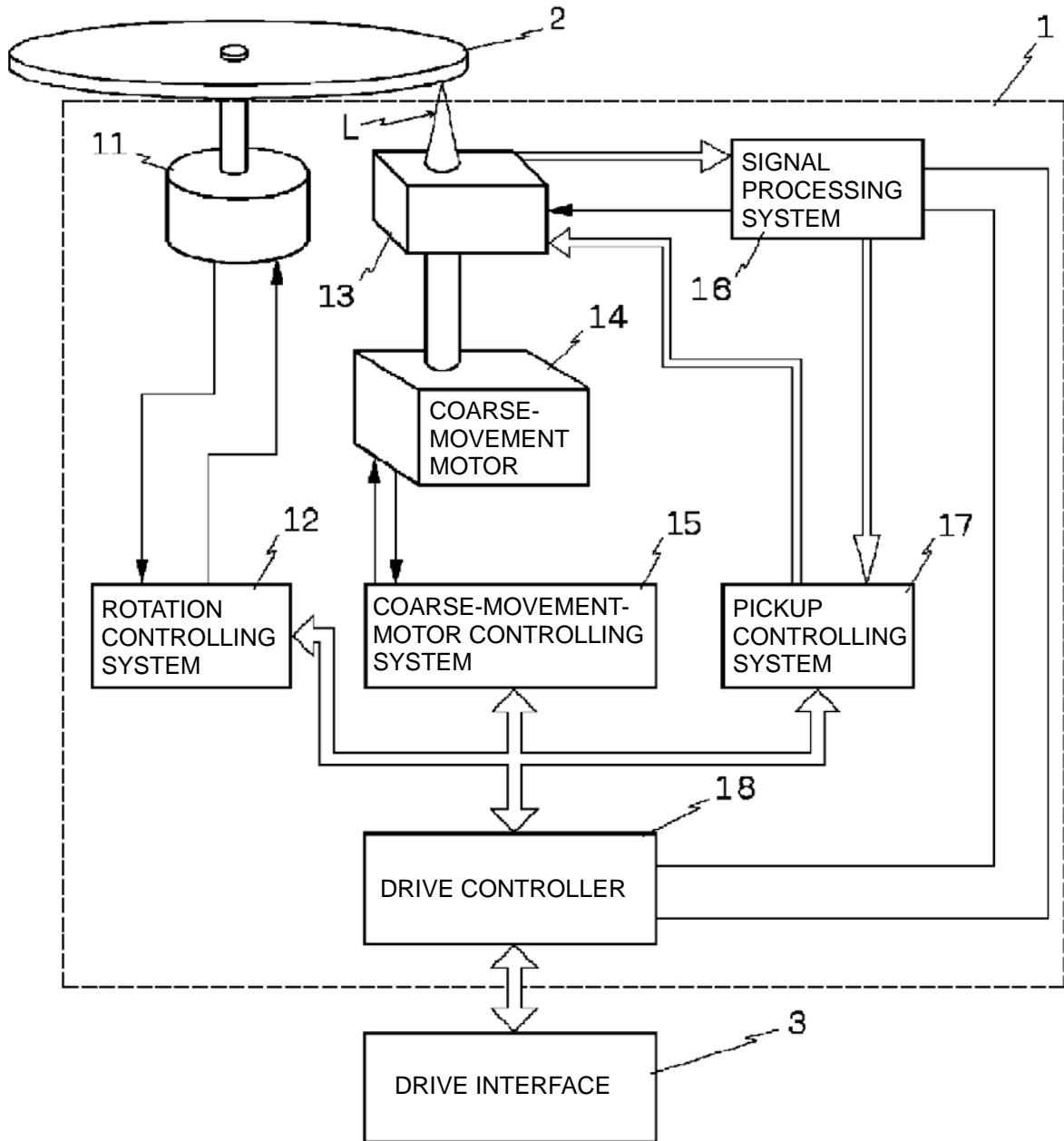

Appendix 1

FIG. 2

ITEM	ISO STANDARD VALUE
Axial Deflection	10.3 mm or less
Axial Acceleration	20 m/S ² or less
Radial Runout	50 μm or less
Radial Acceleration	6 m/S ² or less
Tilt	5 m rad or less

FIG. 3

	1800 rpm	2400 rpm	3000 rpm	3600 rpm
Axial Acceleration	20m/S ²	26.7m/S ²	55.6m/S ²	80m/S ²
Radial Acceleration	6m/S ²	10.7m/S ²	18.3m/S ²	24m/S ²

FIG. 4

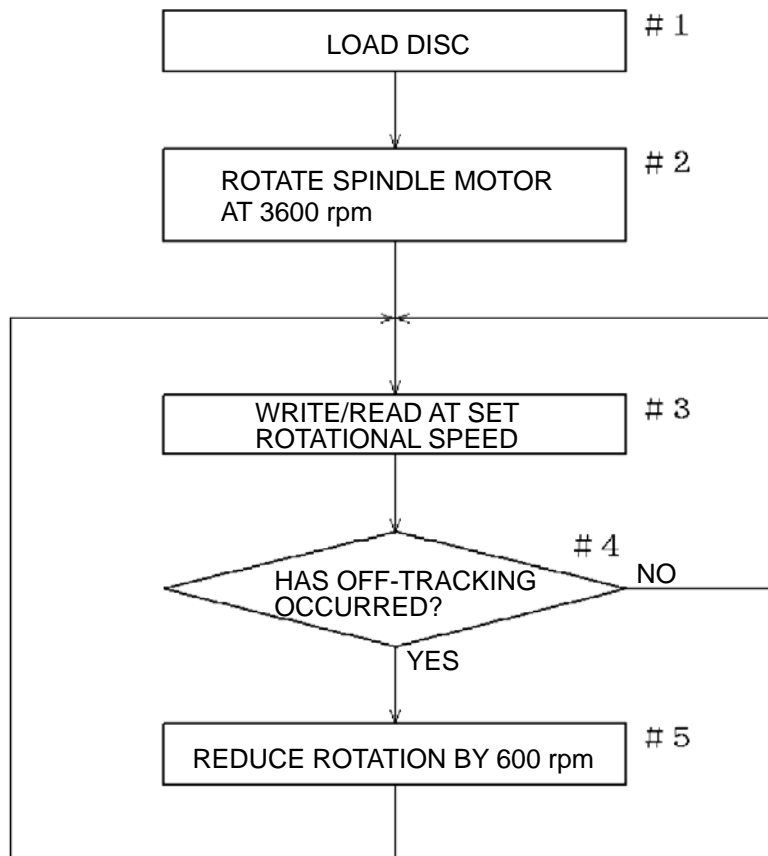

FIG. 5

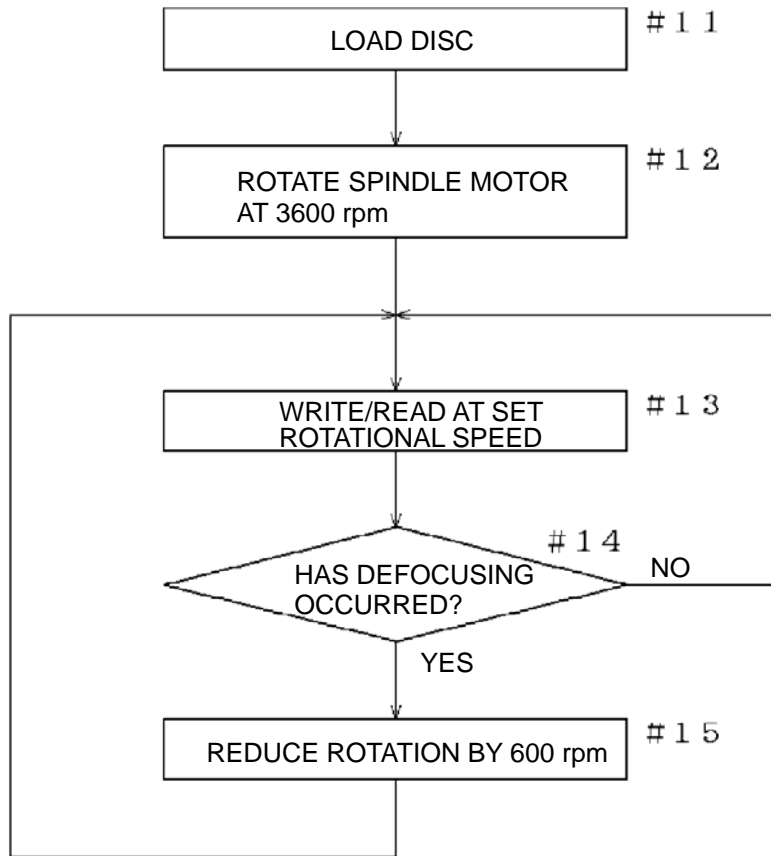
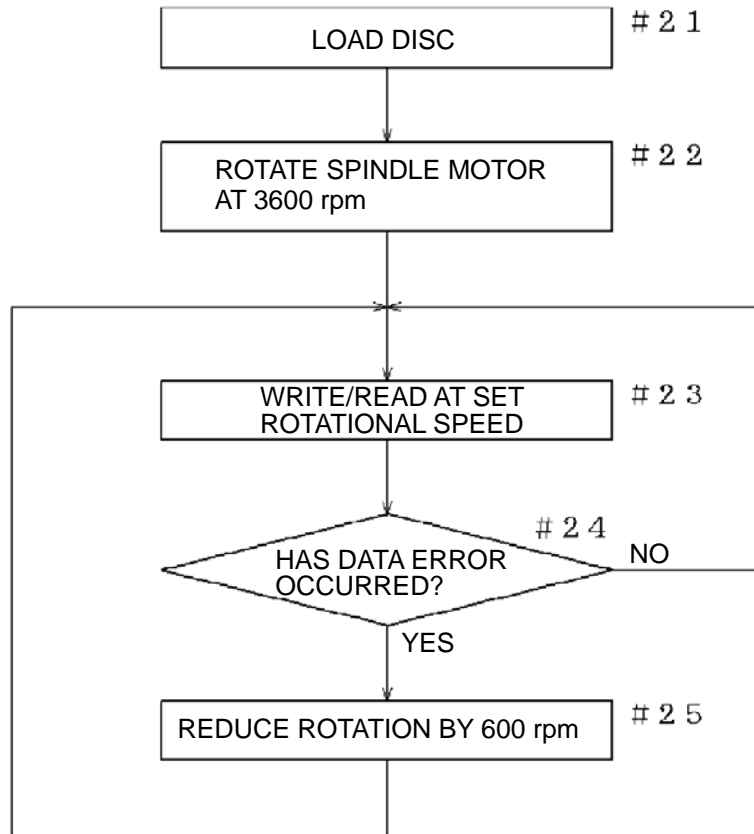

FIG. 6



Case 1

[Published Prior Art 1]

Appendix 1

Claims

1. An information recording/reproducing method for recording or reproducing information by rotating a disk-shaped recording medium by means of a drive motor whose speed is variable, in which in order to correct error data during reproduction of an arbitrary sector, an error correction code is recorded in the sector, the information recording/reproducing method comprising determining the number of error corrections performed for each sector; and reducing the rotational speed of the drive motor when the number of error corrections is larger than a predetermined value.

2. The information recording/reproducing method according to Claim 1, wherein in an information recording/reproducing apparatus having a high-speed rotation mode, reproduction is initially performed in the high-speed rotation mode, the rotational speed of the recording medium during recording is determined using the number of error corrections, and when it is determined that the recording has been performed in a low-speed rotation mode, the rotational speed of the drive motor is reduced to the rotational speed of the low-speed rotation mode.

Detailed Description of the Invention

Field of Industrial Application

Appendix 1

The present invention relates to an information recording/reproducing method for recording or reproducing information using a disk-shaped recording medium, such as a magneto-optical disk, an optical disk, or a magnetic disk, while rotating the medium by means of a drive motor.

Related Art

Recently, with the high-speed operations of computers (CPUs), the demands for high-speed operations of information recording/reproducing apparatuses, which are one type of peripheral apparatus used therewith, have increased. There have also been demands for data compatibility with systems that use apparatuses and media of the related art.

In the related art, therefore, the rotational speed of recording media is increased to improve the data transfer rate without changing the shape, format, etc., of the recording media.

Problems to be Solved by the Invention

When a recording medium having information recorded at low-speed rotation by an apparatus of the related art is to be rotated at a high speed to perform reproduction, due to the large variations in the write positions of the information (generally referred to as jitter), resulting in an error, the reliability of data reproduction may be reduced. Therefore, desirably, even an information recording/reproducing apparatus having a high-speed rotation

Appendix 1

mode with a high rotational speed controls the rotational speed of a drive motor so that a reproduction operation is performed on a medium recorded at low-speed rotation by reducing the rotational speed. However, in order to achieve high-rate data transfer, it is more preferable that even a medium recorded at low-speed rotation be reproduced by high-speed rotation, and it is not advisable to perform reproduction uniformly by low-speed rotation, that is, it is preferable to perform a reproduction operation by rotation at as high a speed as possible.

That is, in the related art, there is no suitable solution for challenging compatible reproduction operations of recording media having information recorded at low-speed rotation by means of apparatuses having a high-speed rotation mode.

Means for Solving the Problem

In an information recording/reproducing method for recording or reproducing information by rotating a disk-shaped recording medium using a drive motor whose speed is variable, in which in order to correct error data during reproducing of an arbitrary sector, an error correction code is recorded in the sector, the number of error corrections performed for each sector is determined; and the rotational speed of the drive motor is reduced when the number of error corrections is larger than a predetermined value.

Appendix 1

More specifically, in an information recording/reproducing apparatus having a high-speed rotation mode, reproduction is initially performed in the high-speed rotation mode, the rotational speed of the recording medium during recording is determined using the number of error corrections, and when it is determined that the recording has been performed in a low-speed rotation mode, the rotational speed of the drive motor is reduced to the rotational speed of the low-speed rotation mode.

Operation

In a reproduction operation performed while rotating a recording medium at a certain rotational speed, if the rotational speed of the reproduction process is higher than the rotational speed of the recording process, this may cause an increase in the amount of error data. On the other hand, even though the rotational speed of the reproduction process is higher than the rotational speed of the recording process, information that is recorded under good conditions can be reproduced with a small amount of error data. Such error data in the reproduction process is corrected for an error at each time point using an error correction code in the sector, and therefore the number of error corrections can be a measure for determining whether the rotational speed of the medium is maintained or reduced in the reproduction process. That is, when the number of error

Appendix 1

corrections performed is small, there is no problem in performing reproduction while keeping the rotational speed.

Assuming an apparatus having a high-speed rotation mode, it is suitable that even for a recording medium recorded at low-speed rotation, a reproduction operation be performed by reducing the rotational speed to that of the recording process only when the state of the recording is bad, and, if the state of the recording is good, the rotational speed is not reduced while keeping the rotational speed of the high-speed rotation mode. Thus, data in the recording medium recorded at low-speed rotation can be made compatible without reducing the data transfer rate. Since the number of corrections performed using error correction codes is used, no special change, writing, etc., are required for the medium.

Embodiments

An embodiment of the present invention will be described with reference to the drawings. The embodiment is given in the context of an optical information recording/reproducing apparatus using an ISO-standard 5.25-inch magneto-optical disk as a recording medium.

Fig. 2 shows an example structure of a magneto-optical disk drive apparatus 2 having a high-speed rotation mode for a magneto-optical disk 1. First, the magneto-optical disk 1 is directly connected to and rotated by a drive motor 4

Appendix 1

whose speed is controlled by a rotation control system 3. An optical pickup 6 that is caused by a coarse adjustment motor 5 to perform seek-movement in the disk radial direction with respect to the magneto-optical disk 1 is provided. The coarse adjustment motor 5 is controlled by a coarse-adjustment-motor control system 7. The optical pickup 6 is configured to focus laser light for recording or erasing on the magneto-optical disk 1. Information based on reflected light is sent to a signal processing system 8, and information relating to tracking/focus servo is sent to a pickup control system 9, so that a tracking/focus actuator in the optical pickup 6 is servo-controlled. Reproduction data and the like detected by the signal processing system 8 are sent to a drive controller 10, and are transferred via a drive interface. Recorded data is sent to the optical pickup 6 along the reverse path. A magnetic-field applying apparatus that is provided on the opposite surface side so as to face the optical pickup 6 with respect to the magneto-optical disk 1 is also used for recording, but is not shown here.

The recording/reproduction operation for the magneto-optical disk 1 is performed on a sector-by-sector basis, where a sector is a collection of certain data. General formats of the ISO standard are shown in Figs. 3 and 4. Fig. 3 shows an example of 512 bytes/sector, and Fig. 4 shows an

Appendix 1

example of 1024 bytes/sector. In the figures, numerals "1" to "512" or "1" to "1024" denote data bytes; symbols "P1, 1" to "P3, 4" denote control codes; symbols "CRC1" to "CRC4" denote error detection codes; symbols "E1, 1" to "E5, 16" or "E1, 1" to "E10, 16" denote error correction codes; and symbols "SB1" to "SB3" and "RS1" to "RS40" or "RS1" to "RS59" denote synchronization signals.

Here, when focusing on the error correction codes represented by "E1, 1" to "E5, 16" or "E1, 1" to "E10, 16", they are configured so that error correction codes for 16 words are added to each vertical data column. For one correction, error correction codes for two words are used, and up to eight words are therefore correctable in the vertical-column data. The recording of such error correction codes is a well-known operation that is performed on error correction code fields of the corresponding column in the sector in order to correct error data in the reproduction process.

In the embodiment, the number of error corrections performed in such a manner is used as a measure for the control of switching the rotational speed of the drive motor 4. First, when the magneto-optical disk 1 is set in the optical disk drive 2 having a high-speed rotation mode shown in Fig. 2, in the initial state, the magneto-optical disk 1 is rotated in the high-speed rotation mode to perform a

Appendix 1

recording operation or reproduction operation. In the reproduction operation, recorded data such as data or a directory is read by the optical pickup 6, and is read by the drive controller 10 through a modulator/demodulator 11 of the signal processing system 8. In that data, as shown in Fig. 1, error-correction-code information is decoded by an error correction encoder/decoder 12 and is then supplied to the drive controller 10, and the decoded information on the number of error corrections is also supplied to the drive controller 10. If the number of error corrections is larger than a predetermined value, e.g., four words, the drive controller 10 determines that the set magneto-optical disk 1 has been written in the low-speed rotation mode, and performs the subsequent recording operation or reproduction operation by switching to the rotational speed of the low-speed rotation mode. Accordingly, when the number of error corrections is small, the operation is continued in the initial high-speed rotation mode. The case where the number of error corrections is small includes not only a case of the recording in the high-speed rotation mode but also a case of the recording in the low-speed rotation mode when the state of the recording is good. On this account, a signal for switching the rotational speed depending on the number of error correction codes is supplied from the drive controller 10 to the rotation control system 3. In this

Appendix 1

manner, since there is no problem as long as the number of error corrections is smaller than a predetermined value, the reproduction operation in the high-speed rotation mode can be continued, and even data recorded in the low-speed rotation mode can be reproduced without reducing the data transfer rate as much as possible. Of course, when a large number of data errors are present, the rotational speed is switched to the rotational speed of the low-speed rotation mode, resulting in a reproduction operation with high data reliability.

Advantages

In the present invention, as described above, the rotational speed of a drive motor is reduced when the number of error corrections performed is large, whereby data that is recorded under good conditions even on a medium recorded at a rotational speed lower than the rotational speed of the reproduction process, can be reproduced at high-speed rotation, and the rotational speed is reduced only when a large amount of error data is present to ensure the data reliability. Therefore, particularly in an apparatus having a high-speed rotation mode, a recording medium recorded by a low-speed-rotation-mode apparatus can be reproduced in the high-speed rotation mode as much as possible, and compatibility can be maintained without reducing the data transfer rate. Further, with the use of error correction

Appendix 1

codes, no special change, writing, etc., are required for the recording medium.

Brief Description of the Drawings

The figures show an embodiment of the present invention, in which Fig. 1 is a block diagram showing the transmission of the number of error corrections performed; Fig. 2 is a block diagram showing the overall structure; and Figs. 3 and 4 are diagrams showing general format examples of the ISO standard.

1: recording medium, 4: drive motor

Appendix 1

FIG. 1

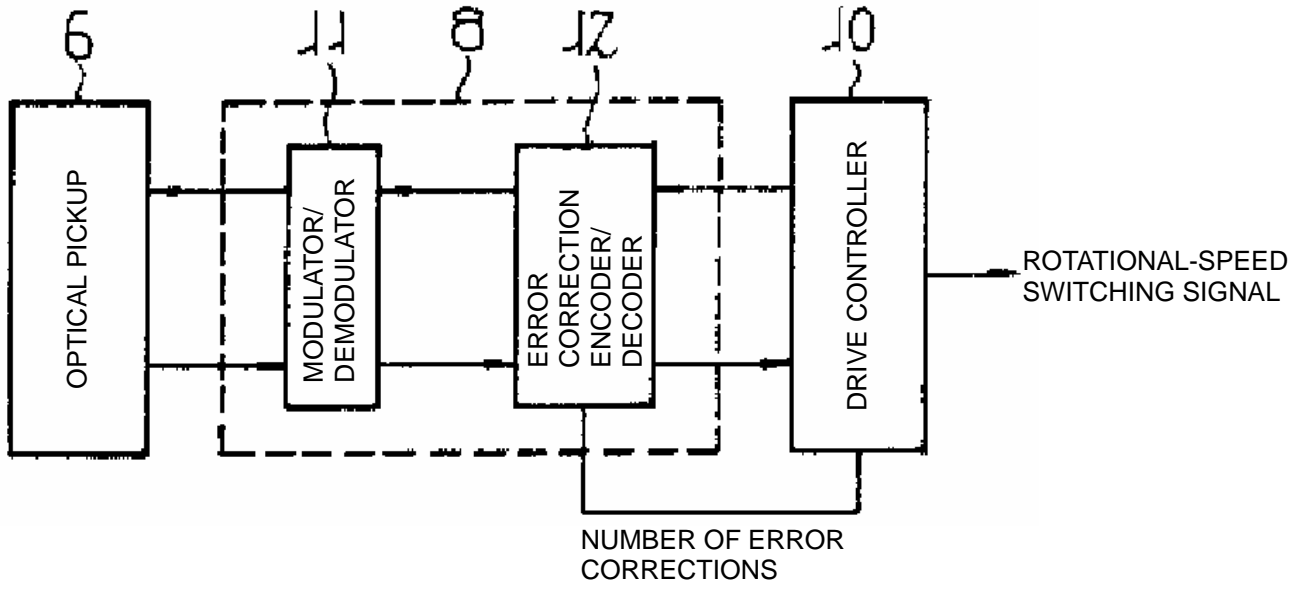
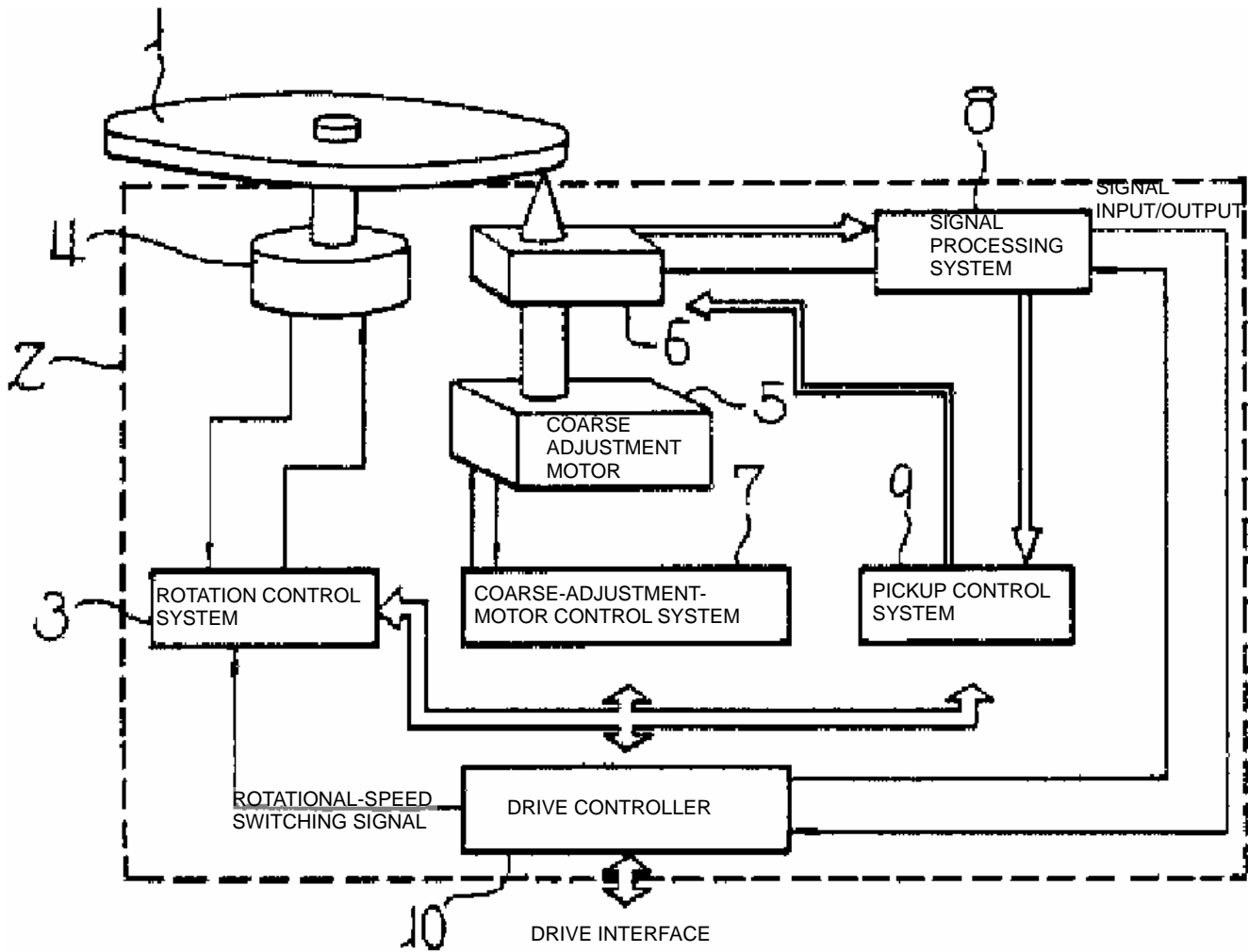
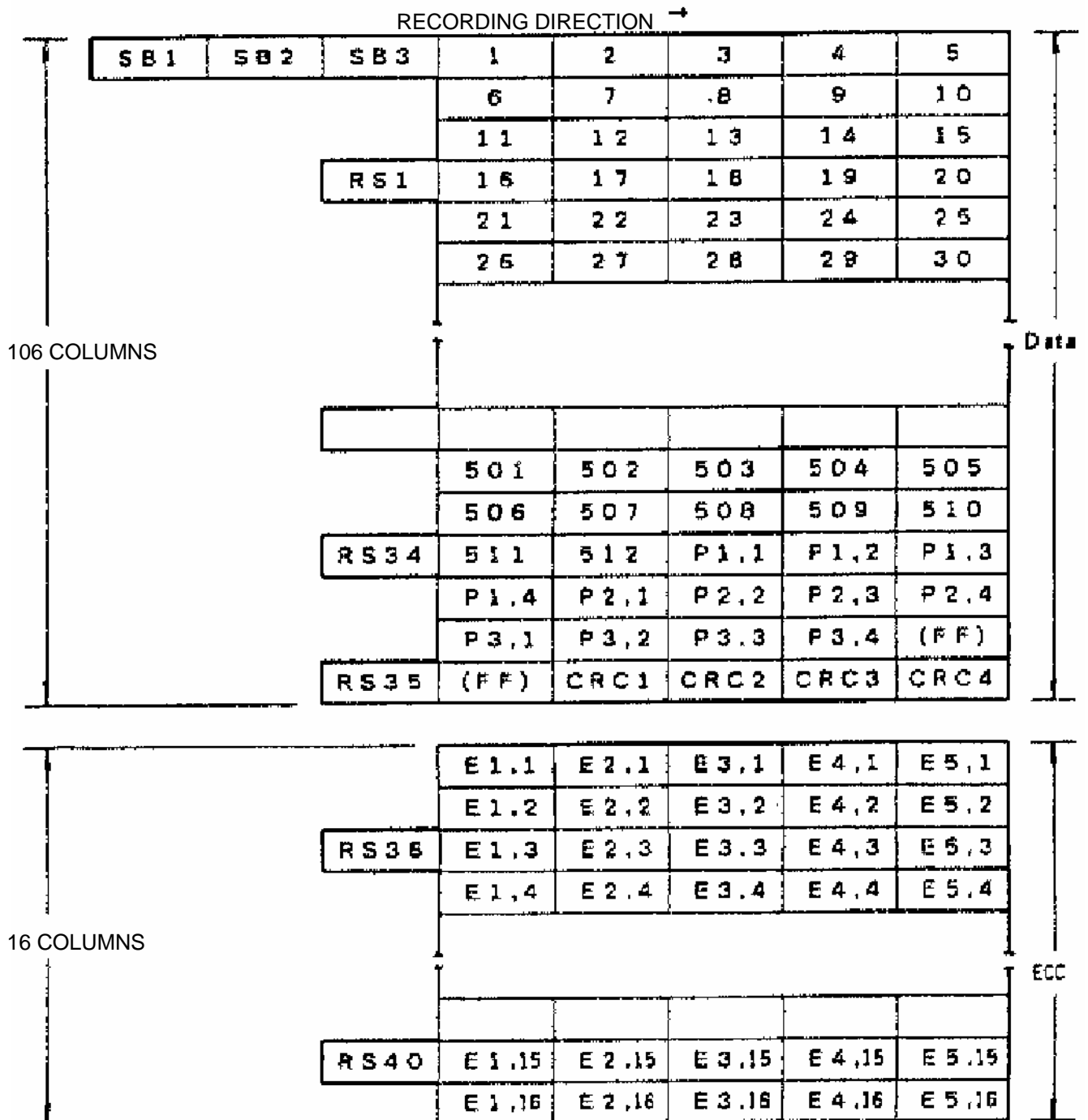

FIG. 2



Appendix 1

FIG. 3



Appendix 1

FIG. 4

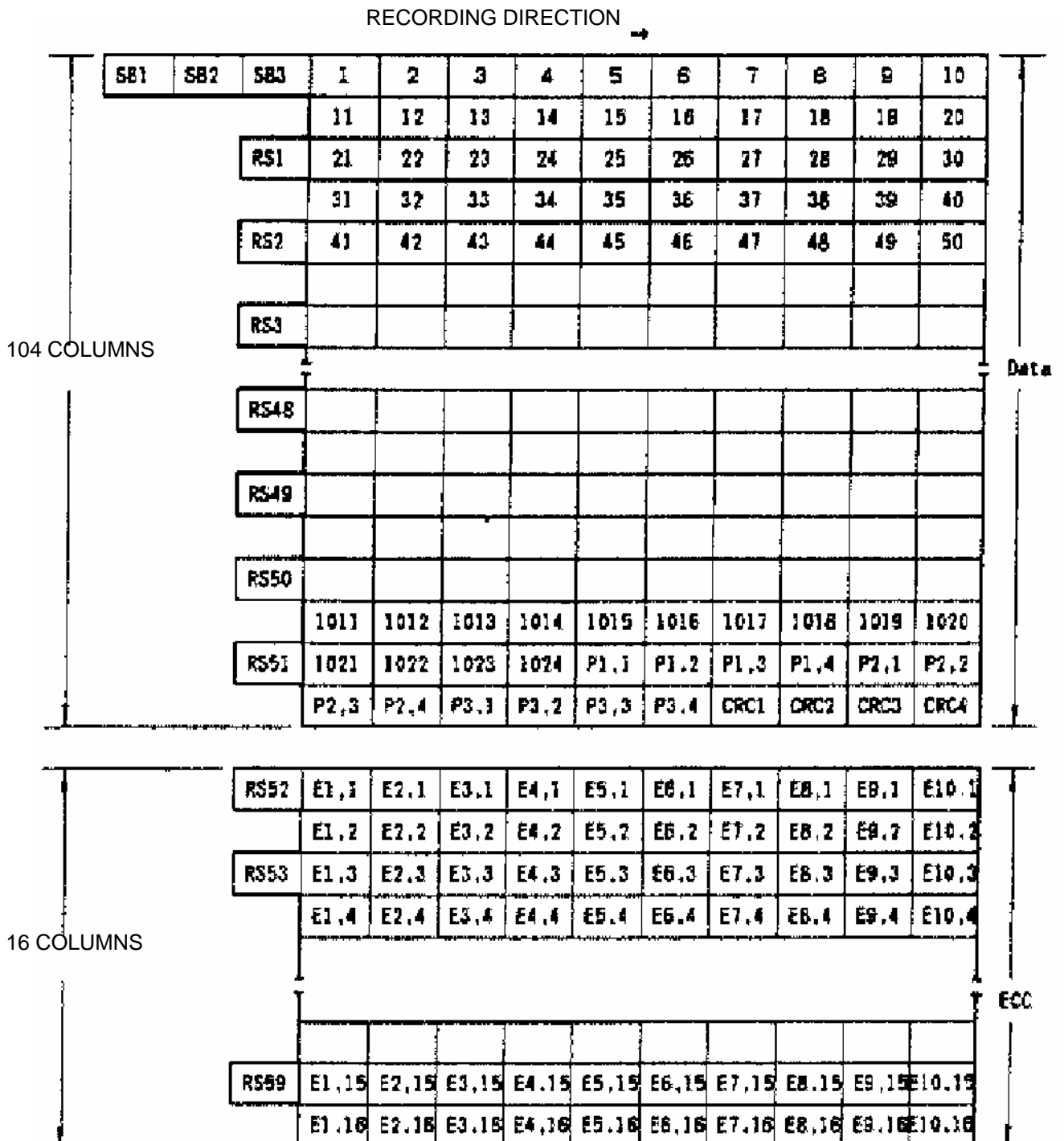

Case 1

[Published Prior Art 2]

Appendix 1

Claim

1. A communication speed setting system for a facsimile apparatus including a modem that is connected to a general subscriber line and that has a communication speed switching function, a level detection circuit that detects a signal level on the line, an A/D conversion circuit that A/D converts an output signal of the level detection circuit, and a control circuit that determines an optimum communication speed on the basis of an output signal of the A/D conversion circuit, wherein a transmitting side of the facsimile apparatus transmits a predetermined line-quality measurement modem signal after establishing a connection with the line; a receiving side of the facsimile apparatus computes the S/N ratio of the line on the basis of a received signal level of the line-quality measurement modem signal and a noise level upon silence, determines the optimum communication speed, and informs the transmitting side of the facsimile apparatus of the communication speed; and the transmitting side of the facsimile apparatus sets the speed informed by the receiving side of the facsimile apparatus to the modem and communicates an image signal.

Detailed Description of the Invention

[Field of Industrial Application]

The present invention relates to a modem speed setting

Appendix 1

system for facsimile communication.

[Related Art]

In facsimile communication for communicating image information via a general subscriber line, high-speed modems at 9600 BPS or the like are often used to reduce communication time. Taking into consideration that the quality of the line may be low, the modem can select a fallback speed of, for example, 7200 BPS, 4800 BPS, 2400 BPS, or the like. Conventionally, the communication speed in facsimile communication using such a modem has been determined by transmitting, by a transmitting side, predetermined test data at the highest communication speed of the modem. In turn, a receiving side determines whether the communication speed is appropriate for the line quality on the basis of the number of error bits in the received test data and informs the transmitting side of an affirmative or negative response. Only when the affirmative response is informed by the receiving side, the transmitting side specifies the communication speed to the modem and transmits image information. However, in the case of notification of the negative response, the transmitting side tries to transmit the test data at the same communication speed again or transmits the test data again at the next highest communication speed. Until receiving the affirmative response from the receiving side, the

Appendix 1

transmitting side repeatedly transmits the test data, reducing the communication speed each time.

[Problems to be Solved by the Invention]

When the line quality is very low, it requires a considerable amount of time for the highest communication speed to fall back to an optimum communication speed.

It is an object of the present invention to provide a communication speed setting system for a facsimile apparatus in which a transmitting side of the facsimile apparatus transmits a line-quality measurement signal, and a receiving side of the facsimile apparatus determines an optimum communication speed on the basis of a signal level of the line-quality measurement signal and a noise level upon silence and informs the transmitting side of the facsimile apparatus of the appropriate communication speed, thereby selecting the optimum communication speed without requiring a large amount of time for the communication speed to fall back to the optimum communication speed.

[Means for Solving the Problems]

According to the present invention, there is provided a communication speed setting system for a facsimile apparatus including a modem that is connected to a general subscriber line and that has a communication speed switching function, a level detection circuit that detects a signal level on the line, an A/D conversion circuit that A/D converts an output

Appendix 1

signal of the level detection circuit, and a control circuit that determines an optimum communication speed on the basis of an output signal of the A/D conversion circuit, wherein a transmitting side of the facsimile apparatus transmits a predetermined line-quality measurement modem signal after establishing a connection with the line; a receiving side of the facsimile apparatus computes the S/N ratio of the line on the basis of a received signal level of the line-quality measurement modem signal and a noise level upon silence, determines the optimum communication speed, and informs the transmitting side of the facsimile apparatus of the communication speed; and the transmitting side of the facsimile apparatus sets the speed informed by the receiving side of the facsimile apparatus to the modem and communicates an image signal.

[Embodiment]

Next, an embodiment of the present invention will be described with reference to Fig. 1.

Referring to Fig. 1, a facsimile line signal 10 is input to a network control circuit 1. An output signal 11 of the network control circuit 1 is input to a level detection circuit 2 and a modem 5. An output 12 of the level detection circuit 2 is A/D converted by an A/D conversion circuit 3 and is input to a control circuit 4.

Appendix 1

The control circuit 4 includes a microprocessor or the like having a memory. An output 14 of the control circuit 4 is input to the modem 5. An output 16 of the modem 5 is input to an encoding/decoding circuit 6. An output 18 of the encoding/decoding circuit 6 is input to a recording circuit 8. An output 17 of a read circuit 7 is input to the encoding/decoding circuit 6.

Next, the operation of each element will be described. After a connection with a line is established, a DC component of a line-quality measurement signal from a transmitting side of a facsimile apparatus is removed by the network control circuit 1 of a receiving side of the facsimile apparatus, and the resulting signal is amplified for absolute level measurement by the level detection circuit 2. The amplified signal is quantized by the A/D conversion circuit 3, input to the control circuit 4, and stored as a signal level in the memory in the control circuit 4. Similarly, a noise level upon silence on the line is stored in the memory in the control circuit 4. The control circuit 4 computes the S/N ratio of the line on the basis of the measurement results of the signal level and the noise level and refers to a table of the modem's optimum communication speeds with respect to S/N ratios, which is stored in advance in the memory, to determine an optimum communication speed. Further, the control circuit 4

Appendix 1

generates a modem speed response signal for the transmitting side of the facsimile apparatus and informs the transmitting side of the facsimile apparatus of the generated modem speed response signal via the modem 5 and the network control circuit 1. The transmitting side of the facsimile apparatus sets the modem to the communication speed informed by the modem communication response signal and communicates image information.

Fig. 2 shows an exemplary communication procedure between the transmitting side of the facsimile apparatus and the receiving side of the facsimile apparatus according to this system. After detecting a ringer signal from a switchboard, the receiving side of the facsimile apparatus transmits an answer tone signal and a terminal identification signal. The transmitting side of the facsimile apparatus informs the receiving side of the facsimile apparatus of information regarding the encoding system, the line density, the document size, or the like by sending a communication mode setting signal. After a silence interval of a predetermined period, the transmitting side of the facsimile apparatus transmits an image information communication modem signal as a line-quality measurement signal. The receiving side of the facsimile apparatus measures the noise level of the line in the silence interval and the signal level of the quality-line

Appendix 1

measurement signal and computes the S/N ratio. Thereafter, the receiving side of the facsimile apparatus determines an optimum communication speed and informs the transmitting side of the facsimile apparatus of the optimum communication speed by sending a modem speed response signal. The transmitting side of the facsimile apparatus transmits an image information signal at the communication speed informed by the modem speed response signal.

[Advantages of the Invention]

According to the present invention, as has been described above, a receiving side of a facsimile apparatus determines an optimum communication speed on the basis of the S/N ratio of a line and informs a transmitting side of the facsimile apparatus of the optimum communication speed, thereby advantageously reducing the time required from establishment of a line connection to determination of the optimum communication speed, especially in the case of low line quality.

Brief Description of the Drawings

Fig. 1 is a block diagram showing an embodiment of the present invention, and Fig. 2 is a diagram showing a transmission procedure of a transmitting side and a receiving side.

1: network control circuit, 2: level detection

Appendix 1

circuit, 3: A/D conversion circuit, 4: control circuit,
5: modem, 6: encoding/decoding circuit, 7: read circuit,
8: recording circuit

FIG. 1

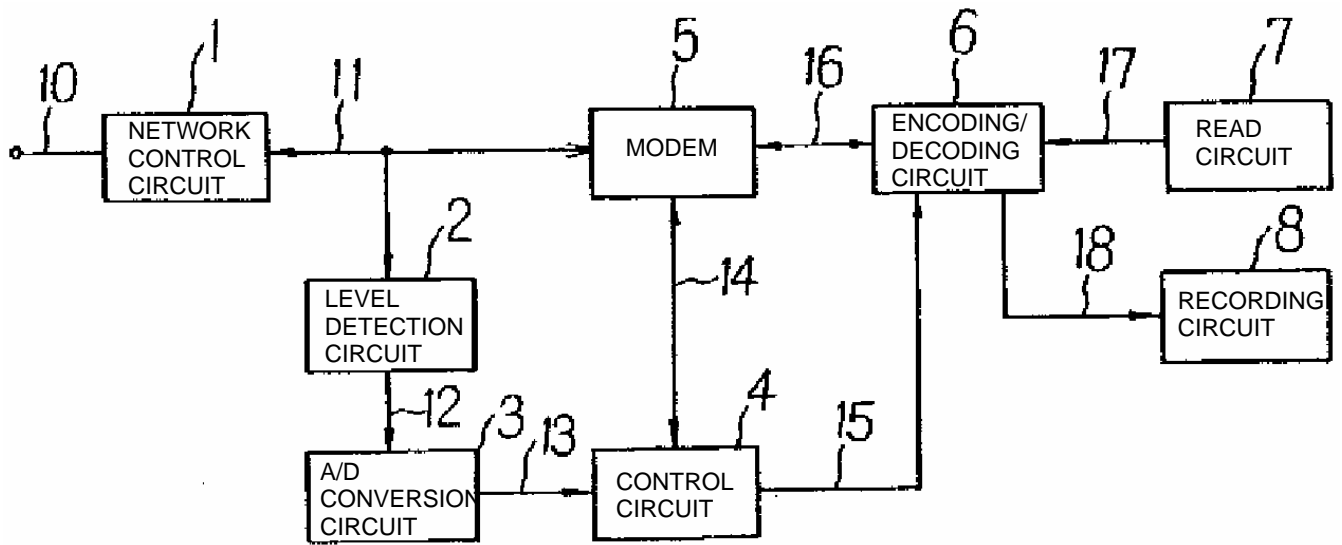

FIG. 2

